

AUTOBOX ABX-PRO

Automated Hose Tractor for Small Pipe Cleaning

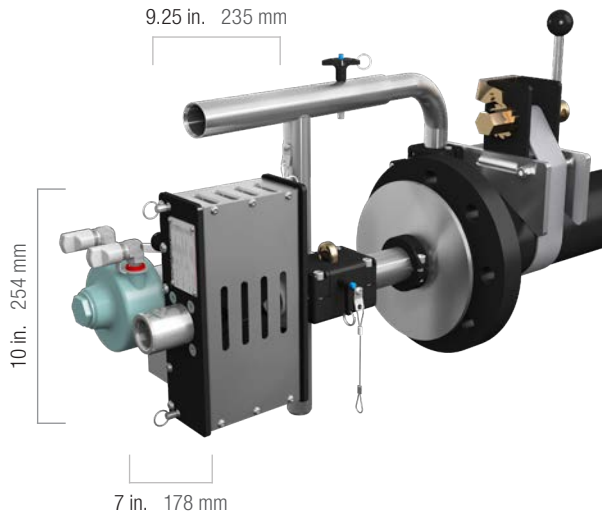

OVERVIEW

The AutoBox ABX-PRO is a hose feed tractor engineered with safety, portability and quick setup in mind. This versatile device is designed with multiple mounting options and accessories to adapt it for a wide variety of pipe, drain and tube cleaning applications.

The ABX-PRO is the perfect tool for limited access applications and includes a lightweight control box for increased safety and mobility.

COMPETITIVE ADVANTAGES

- Comes standard with strap and bolt-on mounting accessories for safe pipe cleaning “out of the box”
- Utilizes a first-of-its-kind corrosion-resistant motor
- Weighs only 25 lbs (11 kg)
- All parts are stocked and ready to ship same day to minimize work interruption
- Ultra-portable positioner for single tube lancing
- Easily adaptable for drain cleaning
- Full line of accessories available to help you make the most of your equipment investment

FEATURES	BENEFITS
<ul style="list-style-type: none"> • Ultra-portable system design 	<ul style="list-style-type: none"> • Ideal for limited access applications
<ul style="list-style-type: none"> • Multiple roller sizes handle hoses from 0.26–0.98 OD 	<ul style="list-style-type: none"> • A single system can handle a wide range of tube/pipe/drain cleaning applications — less equipment to buy
<ul style="list-style-type: none"> • Independent forward/reverse speed control from 0.2–2.5 ft/sec 	<ul style="list-style-type: none"> • Consistent cleaning in both directions produces better results in less time
<ul style="list-style-type: none"> • Multiple mounting options for pipes with or without a flange 	<ul style="list-style-type: none"> • Quick, easy setup for challenging or unique applications
<ul style="list-style-type: none"> • Portable, ergonomic control box — pedestal-style and hand-held versions available 	<ul style="list-style-type: none"> • Operate all features from outside the blast zone for safety and better line of sight
<ul style="list-style-type: none"> • Built in back-out preventer and splash guard 	<ul style="list-style-type: none"> • Increases job site safety
<p>FULL RANGE OF HOSE STOPS, COLLETS, GUIDE TUBES, AND NOZZLES AVAILABLE</p>	

AUTOBOX ABX-PRO OVERVIEW

CONSIDERATIONS

- Are you cleaning pipes or exchanger tubes?

If cleaning pipes:

- What size pipe are you cleaning?
- Will you mount the system to a pipe flange or use a strap mount?
- Will you require a splash plate?
- Do you have accessibility limitations that can be aided with a 45° snout?

If cleaning exchangers:

- What is the size/diameter of the exchanger?
- What is the tube length and ID?
- How will you mount the positioner to the exchanger? *Standard and clamp mounts available.*
- Does the exchanger have a channel head? *Depth will determine length of guide tubes.*
- Are you cleaning the tube face? *Face cleaning attachment available.*

OTHER INFORMATION

The AutoBox ABX-PRO is well suited for use with Beetle and 2" Badger tools.

TOOL SPECIFICATIONS

MODEL	ABX-PRO
Pipe Size	2–8 in. 51–203 mm
Feed Rate	1.0–32 in/sec 25–813 mm/s
Hose Size	0.26–0.98 OD
Dimensions	7 in. x 9.25 in. x 10 in. 178 mm x 235 mm x 254 mm
Weight	25 lb 11.3 kg

Visit our website for tool resources including operation and maintenance videos:

WWW.STONEAGETOOLS.COM

AUTOBOX ABX-PRO CONFIGURATION

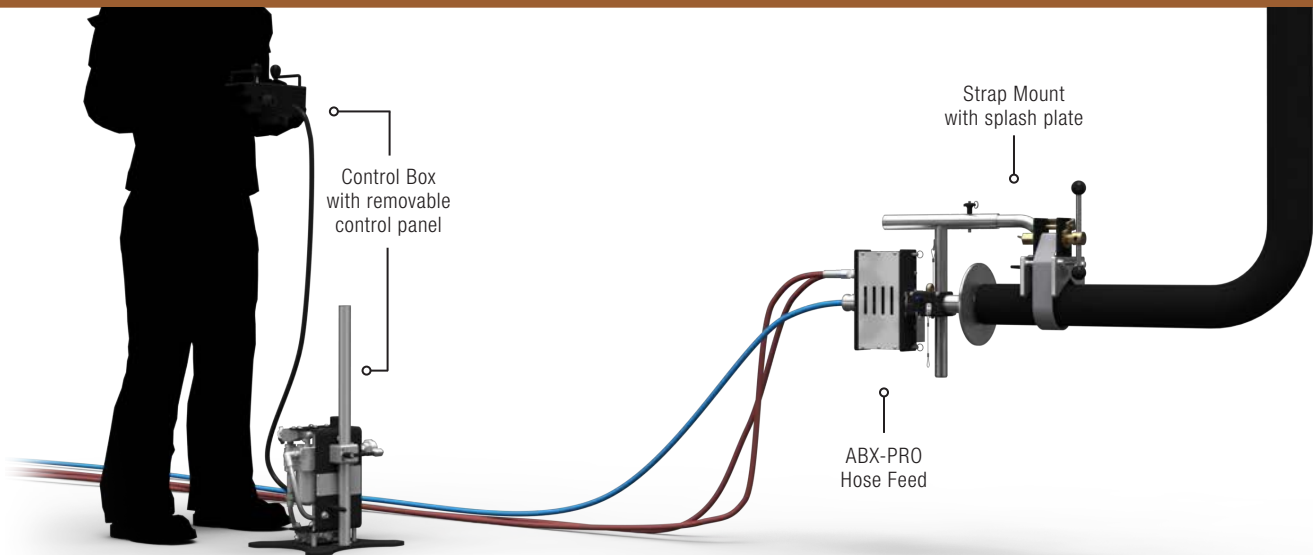

A complete AutoBox ABX-PRO configuration includes the following components:

1. Hose tractor assembly
2. Hose stop collet of appropriate size
3. Control box

The following items may also be requested:

- Additional roller and collet sizes
- Snout options
- Splash plates or flange mount options
- Positioner for exchanger cleaning

AUTOBOX ABX-PRO CONFIGURATION

TUBE CLEANING PACKAGES

StoneAge offers complete packages for the AutoBox ABX-PRO that include a ProPositioner and component parts for effective exchanger cleaning, delivered in a portable job box.

The ultra-portable ProPositioner utilizes 2.5-inch (64 mm) rail components and can be mounted to a variety of heat exchanger tube bundles.

Standard rail length is 3.75 ft (1.14 m) and can be extended to a maximum total length of 5 ft (1.52 m).

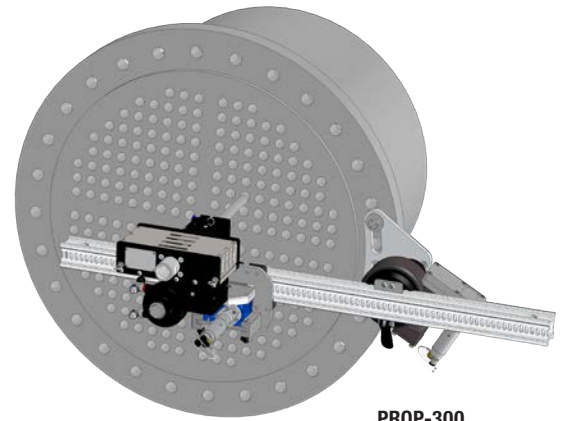

PROP-300
ProPositioner

BASIC PACKAGE **AUTO-PROP-PKG**

The AUTO-PROP-PKG is a basic package that includes the **ABX-PRO tractor with ProPositioner and essential component parts for exchanger cleaning.**

QTY	DESCRIPTION	PART ID
1	AutoBox ABX-PRO (ProDrive) Tractor Assy, 20-1 (.46 roller installed)	ABX-PRO
1	Hose Stop Adaptor	BOP 048
1	ProPositioner Assembly	PROP-300
1	Control Box, ProPositioner	CB-PROP-?
1	Kit, Collet-Roller-Hose Stop w/Case	GPT 106
1	Guide Tube Kit, 12 Inch, BN9.5-BN18	PROP 490-S
1	AutoPack ProPositioner Chest	GPT 070-PROP
1	Magnet Graphic, Visual Aide for Auto-PROP Parts	PL 198
1	Industry Best Practices for the use of HP Waterjetting Equipment	PL 310
1	Binder, AUTO-PROP	PL 678

? Specify desired Control Box option

AUTOBOX ABX-PRO CONFIGURATION

COMPLETE PACKAGE

AUTO-PROP-1-PKG

The AUTO-PROP-1-PKG is a complete package that includes the **ABX-PRO tractor with ProPositioner and all component parts for exchanger cleaning.**

QTY	DESCRIPTION	PART ID
1	AutoBox ABX-PRO (ProDrive) Tractor Assy, 20-1 (.46 roller installed)	ABX-PRO
1	Hose Stop Adaptor	BOP 048
1	ProPositioner Assembly	PROP-300
1	Control Box, ProPositioner	CB-PROP-?
1	Kit, Collet-Roller-Hose Stop w/Case	GPT 106
1	Guide Tube Kit, 12 Inch, BN9.5-BN18	PROP 490-S
1	Guide Tube Kit, 12 Inch, BN24-BN33	PROP 490-L
1	Rail Mount Assembly	PROP 470
1	Quick Clamp Assembly	PROP 518
1	Box Rail Extention, 3.75 ft, w/round holes	BR 002-3.75-001
1	2.5" Box Rail Extension Kit, Slotted, 1.33 ft	PROP 580-1.33-001
1	Shotgun Mount Assembly	PROP 480
1	Hardline Collet, 9/16 Lance (2 peice halves)	LWP 560-56
2	Tool Bag, 18in	GPT 310
1	AutoPack ProPositioner Chest	GPT 070-PROP
1	Magnet Graphic, Visual Aide for Auto-PROP Parts	PL 198
1	Industry Best Practices for the use of HP Waterjetting Equipment	PL 310
1	Binder, AUTO-PROP	PL 678

? Specify desired Control Box option

AUTOBOX ABX-PRO CONFIGURATION

ACCESSORY PACKAGES FOR TUBE CLEANING

Accessory packages allow you to easily add functionality to your AutoBox ABX-PRO tractor as required.

PROPOSITIONER PACKAGE PART ID **PROP-PKG**

The PROP-PKG package adds the **ProPositioner** for customers who already own an AutoBox ABX-PRO tractor.

QTY	DESCRIPTION	PART ID
1	ProPositioner Assembly	PROP-300
1	Control Box, ProPositioner	CB-PROP-?
1	Hose Stop Adaptor	BOP 048

? Specify desired Control Box option

TUBE CLEANING PACKAGE PART ID **PRO-675-PKG**

The PRO-675-PKG includes **guide tubes and safety stops** for safe and efficient tube cleaning with the AutoBox ABX-PRO.

QTY	DESCRIPTION	PART ID
1	Guide Tube Collet Block Assembly	BOP 035-16
1	Hose Stop Adaptor	BOP 048
1	Guide Tube (Size and Length)	ABX ???-16
1	Hose Stop, Collet Style	FF 121-???
1	Hose Stop, Clamp Style	HS 121-???

??? Specify desired Hose Stop size or Guide Tube size

AUTOBOX ABX-PRO CONFIGURATION

PIPE CLEANING PACKAGES

StoneAge offers AutoBox ABX-PRO packages for safe, effective pipe and drain cleaning. Packages are delivered in a portable job box for convenient tool storage in the field.

COMPLETE PACKAGE **AUTO-PRO-PKG**

The AUTO-PRO-PKG is a complete package that includes the **ABX-PRO tractor and all available sizes of component parts for pipe and drain cleaning in a portable job box.**

QTY	DESCRIPTION	PART ID
1	Guide Tube, .459ID, 16"/406.4mm L (BN9.5)	ABX 115-16
1	Guide Tube, .546ID, 16in/406.4mm L (BN13)	ABX 116-16
1	Guide Tube, .674ID, 16in/406.4mm L (BN15)	ABX 117-16
1	Guide Tube, .745 ID, 16in/406.4mm L (BN18)	ABX 119-16
1	Guide Tube, 1.010 ID, 16in/406.4mm L (BN24)	ABX 125-16
1	Guide Tube, 1.120 ID, 16in/406.4mm L (BN27/BN24)	ABX 126-16
1	Guide Tube, 1.380 ID, 16in/203.2mm L (BN33)	ABX 127-16
1	AutoBox ABX-PRO (ProDrive) Tractor Assy, 20-1 (.46 roller installed)	ABX-PRO
1	Quarter Plate Assy, 2in-4in	BOP 010-2-4-QTR
1	Flange Mount Plate Assy, 4in-8in	BOP 010-4-8
1	Weldment, Splash Plate	BOP 012
1	Collet Block Assembly	BOP 030
1	Guide Tube Collet Block Assy (Fin Fan - does not include guide tubes)	BOP 035-16
1	Hose Stop Adaptor	BOP 048
1	Strap Mount Assembly	BOP 050
1	Tube, Snout, SS, 1.75 x 6in	BOP 081-6
1	Snout Tube, Galvanized, 1.75 x R9 x 45deg	BOP 082-9-45
1	Snout Tube and Cam Lock	BOP 085-K
1	Snout Tube and Cam Lock	BOP 086-K
1	Adapter Kit, CB-ABX-PRO-LWP	CB 870-K
1	Autobox ABX-PRO Control Box Assy, Side Latch	CB-ABX-PRO-100-S
1	AutoPack ABX-PRO chest	GPT 063-APP-001
1	Toolbox Assembly	GPT 105
1	Kit, Collet-Roller-Hose Stop w/Case	GPT 106
1	Tool Bag, 18in	GPT 310
1	Magnet Graphic, Visual Aide for AutoPack-PRO Parts	PL 190
1	Binder, AUTO-PRO	PL 634
1	ProDrain Assembly w/Lanyard Assy	PRO-700-V2

AUTOBOX ABX-PRO CONFIGURATION

BASIC PACKAGE **ABX-PRO-PKG**

StoneAge offers a basic package that includes the **ABX-PRO tractor, control box, and safety components for pipe cleaning**. Positioner not included.

QTY	DESCRIPTION	PART ID
1	AutoBox ABX-PRO (ProDrive) Tractor Assy, 20-1 (.46 roller installed)	ABX-PRO
1	Collet Block Assembly	BOP 030
1	Control Box, ABX-PRO, Pedestal or Side Latch	CB-ABX-PRO-100-?
1	Hose Stop, Collet Style	FF 121-??
1	ABX-PRO-PKG Attention Sheet	PL 651

? Specify desired Control Box option

?? Specify desired Hose Stop size

ACCESSORY PACKAGES FOR PIPE CLEANING

Accessory packages allow you to easily add functionality to your AutoBox ABX-PRO tractor as required.

PIPE CLEANING PACKAGE PART ID **PRO-670-PKG**

Ideal for current owners of the ABX-PRO, the PRO-670-PKG includes **mounting options, backout prevention, splash guards, and flexible snout** for efficient pipe cleaning.

QTY	DESCRIPTION	PART ID
1	Quarter Plate Assy, 2in-4in	BOP 010-2-4-QTR
1	Weldment, Splash Plate	BOP 012
1	Strap Mount Assembly	BOP 050
1	Tube, Snout, SS, 1.75 x 6in	BOP 081-6
2	Tube, Snout, Alum, 1.75 x 1.25 NPT Male	BOP 084
1	Cam Lock 1.25 x 1.25 NPT Female	BOP 085
1	Cam Lock 1.25 Male x 1.25 NPT Female	BOP 086
1	Snout, Corrugated, 1.25 Camlocks, 7ft	BOP 090-7-001-K

DRAIN CLEANING PACKAGE PART ID **PRO-700-PKG**

The PRO-700-PKG adapts the ABX-PRO for **hands-free drain cleaning**.

QTY	DESCRIPTION	PART ID
1	ProDrain Assembly w/Lanyard Assy	PRO-700-PKG
1	Hose Stop, Collet Style	FF 121-???

??? Specify desired Hose Stop size

AUTOBOX ABX-PRO CONFIGURATION

PACKAGE OPTIONS

The following options are available to customize your AutoBox ABX-PRO packages or add additional functionality to your equipment.

Hose Stop Options

The AutoBox ABX-PRO hose feed assembly comes installed with 2 x Ø.46 rollers. Additional sizes can be ordered separately or in kits of two. Hose stops are required safety mechanisms and come in collet and clamp styles. The hose OD determines the sizes needed to interface with the hose selected.

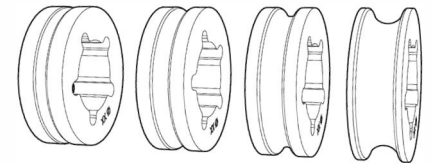
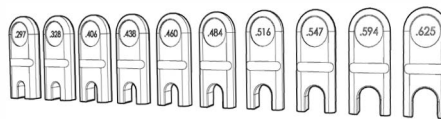
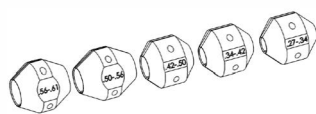

HOSE STOP CLAMPS

HOSE STOP COLLETS

ROLLERS

The table below describes recommended rollers, collets and clamps for common hose sizes:

PRO 174-XX ROLLERS	HOSE OD	RUBBER COATED		SPIRSTAR	PARKER	BACK OUT PREVENTION		HOSE STOP SIZE	HOSE STOP PART NUMBER
		I.D.	O.D.			COLLET SIZE	COLLET		
PRO 174-34 Ø 0.34 IN.	0.26-0.38 IN. (7 mm - 10 mm)	N/A		3/2	2240D-02	0.297 in. / 7.5 mm	FF 121-297	.27-.34 / 7-9 mm	HS 121-27-34
				3/4, 4/2	2240D-025, 2440D-02	0.328 in. / 8.0 mm	FF 121-328	.27-.34 / 7-9 mm	HS 121-27-34
				3/6, 5/2	2240D-03	0.406 in. / 10.0 mm	FF 121-406	.34-.42 / 9-11 mm	HS 121-34-42
4/4	2448D-025			0.438 in. / 11.0 mm	FF 121-438	.34-.42 / 9-11 mm	HS 121-34-42		
PRO 174-46 Ø 0.46 IN.	0.39-0.50 IN. (10 mm - 13 mm)			4/6, 5/4, 6/2	2240D-04	0.460 in. / 12.0 mm	FF 121-460	.42-.50 / 11-13 mm	HS 121-42-50
					2640D-025, 2740D-03	0.484 in. / 12.0 mm	FF 121-484	.42-.50 / 11-13 mm	HS 121-42-50
PRO 174-58 Ø 0.58 IN.	0.51-0.61 IN. (13 mm - 15 mm)	6/4	2440D-04	0.516 in. / 13.0 mm	FF 121-516	.50-.56 / 13-14 mm	HS 121-50-56		
		5/6, 8/2	2240D-05, 2740D-03	0.547 in. / 14.0 mm	FF 121-547	.50-.56 / 13-14 mm	HS 121-50-56		
PRO 174-85 Ø 0.85 IN.	0.81-0.89 IN. (20 mm - 23 mm)	8/4		0.594 in. / 15.0 mm	FF 121-594	.56-.61 / 14-16 mm	HS 121-56-61		
			2440D-05	0.625 in. / 16.0 mm	FF 121-625	.56-.61 / 14-16 mm	HS 121-56-61		
PRO 174-67 Ø 0.67 IN.	0.63-0.71 IN. (16 mm - 18 mm)	.25" (6 mm)	.69" (18 mm)	6/6H	2740D-03, 2748D-05, 2749D-05	STONEAGE RECOMMENDS USING EITHER A BOP 010-4-8 OR BOP 010-9-18 WITH THESE LARGER SIZE HOSES			
PRO 174-76 Ø 0.76 IN.	0.72-0.80 IN. (18 mm - 20 mm)	.375" (10 mm)	.80" (20 mm)	6 mm UHP, 8/6 UHP, 8/6 UHP-X, 10/4, 13/2	2840D-05, 2440N-06				
PRO 174-94 Ø 0.94 IN.	0.90-0.98 IN. (23 mm - 25 mm)	.5" (13 mm)	.91" (23 mm)	13/2 WR	2380N-08, 2440N-08				

Collet Kits

PART ID	DESCRIPTION
PRO 621	Kit (Standard), Collets, (1ea .297 - .516)
PRO 622	Kit (Extended), Collets, (1ea .297 - .625)

Guide Tube Collet Block Options

PART ID	DESCRIPTION
BOP 035-8	Guide Tube Collet Block Assy (Tube Bundles)
BOP 035-16	Guide Tube Collet Block Assy (Fin Fan)

Guide tubes not included. See below for guide tube options.

AUTOBOX ABX-PRO CONFIGURATION

Roller Kits

PART ID	DESCRIPTION
PRO 174-34-K	Kit, Roller, Poly Urethane, .34 (2 rollers)
PRO 174-46-K	Kit, Roller, Poly Urethane, .46 (2 rollers)
PRO 174-58-K	Kit, Roller, Poly Urethane, .58 (2 rollers)
PRO 174-89-K	Kit, Roller, Poly Urethane, .89 (2 rollers)

Guide Tube Options

GUIDE TUBE ID	BANSHEE MODEL	LENGTH	GUIDE TUBE PART ID
0.46 in. 12 mm	BN9.5	8 in. 203 mm	ABX 115-8
		12.5 in. 316 mm	ABX 115-12
		16 in. 406 mm	ABX 115-16
0.55 in. 14 mm	BN13	8 in. 203 mm	ABX 116-8
		12.5 in. 316 mm	ABX 116-12
		16 in. 406 mm	ABX 116-16
0.67 in. 17 mm	BN15	8 in. 203 mm	ABX 117-8
		12.5 in. 316 mm	ABX 117-12
		16 in. 406 mm	ABX 117-16
0.75 in. 19 mm	BN18	8 in. 203 mm	ABX 119-8
		12.5 in. 316 mm	ABX 119-12
		16 in. 406 mm	ABX 119-16
1.01 in. 25 mm	BN24	8 in. 203 mm	ABX 125-8
		16 in. 406 mm	ABX 125-16
1.12 in. 28 mm	BN24, BN27	8 in. 203 mm	ABX 126-8
		16 in. 406 mm	ABX 126-16
1.38 in. 35 mm	BN33	8 in. 203 mm	ABX 127-8
		16 in. 406 mm	ABX 127-16

Control Box Options

PART ID	DESCRIPTION
CB-PRO-P	Control Box, ProPositioner, Pedestal Pipe and Tube Cleaning
CB-PRO-S	Control Box, ProPositioner, Side Latch Pipe and Tube Cleaning
CB-ABX-PRO-100-P	Control Box, ABX-PRO, Pedestal Pipe Cleaning
CB-ABX-PRO-100-S	Control Box, ABX-PRO, Side Latch Pipe Cleaning

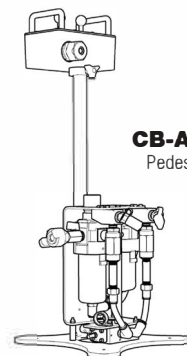

CB-ABX-PRO-100-P
Pedestal style control box

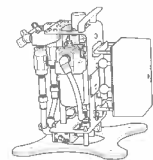

CB-ABX-PRO-100-S
Side latch style control box

AUTOBOX ABX-PRO CONFIGURATION

Face Cleaning Options

PART ID	DESCRIPTION
PROP 480	Shotgun Mount Assembly
LWP 560-56	Hardline Collet, 9/16 Lance (2 peice halves)

ProPositioner Extension Options

PART ID	DESCRIPTION
PROP 580-1.33-001	2.5" Box Rail Extension Kit, Slotted, 1.33 ft

Mounting Options for Tube Cleaning

PART ID	DESCRIPTION
PROP 470	Rail Mount Assembly
LWP 518	Quick Clamp Assembly
BR 002-3.75-001	Box Rail Extention, 3.75 ft, w/round holes

Mounting Options for Pipe Cleaning

PART ID	DESCRIPTION
BOP 010-2-4-QTR	Quarter Plate Assy, 2in-4in
BOP 010-4-8	Flange Mount Plate Assy, 4in-8in
BOP 050	Strap Mount Assembly

Pedestial version required for use with camera

Dump Valve Assemblies

PART ID	DESCRIPTION
ACDA 61001007-K	Kit, Dump Valve Assembly W/Air Hose and Fittings, 15K
ACDA 61020019-K	Kit, Dump Valve Assembly W/Air Hose and Fittings, 20k

For questions or help with a specific application, configuration or tool repairs, please contact StoneAge Customer Service.